



## 4G SOLAR CAMERA

EN

User's manual

DE

Benutzerhandbuch

FR

Manuel de  
l'utilisateur

IT

Manuale d'uso

ES

Manual de usuario

PT

Manual do utilizador

## CAMERA DESCRIPTION

Note:

- 1 Connect the camera to the solar panel and check that the solar panel switch is turned on.
- 2 Turn on the camera switch
- 3 Set the switch on the solar panel to "ON" to turn on and "OFF" to turn off.

### NV-CAM01-SOLAR 4G

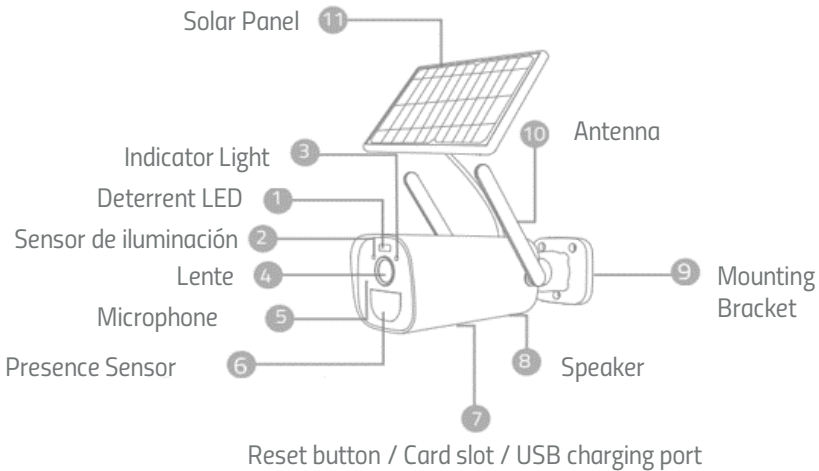

### NV-CAM02S-SOLAR 4G

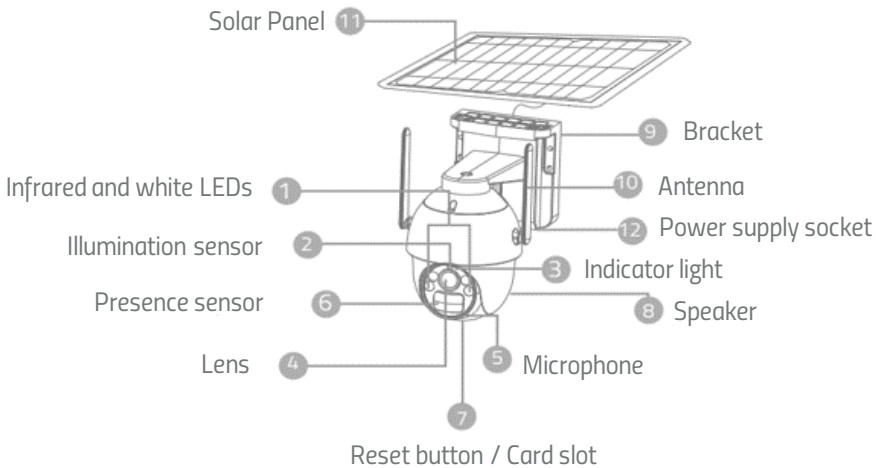

## INSTALLATION TIPS

The PIR presence sensor is sensitive to heat and cold disturbances, please note the following:

The PIR presence sensor is sensitive to heat and cold disturbances, please note the following: Avoid installing the camera where there is air flow agitation. For example: the air outlet of the air conditioner, the heat dissipation port of the equipment, the side of the fan, the vicinity of the curtain, etc. Do not install the camera in front of the glass or mirror. The installation height of the camera should be 2.5m to 3m, the optimal distance for motion detection by the PIR sensor. Do not install the camera upside down.

### Ceiling/Wall Mounting

- 1 Use the installation paper template to make holes, and then insert the toggles to mount the device.
- 2 Installation of camera base.
- 3 Solar mount installation.
- 4 The solar panel is installed outdoors and then connected to the camera.

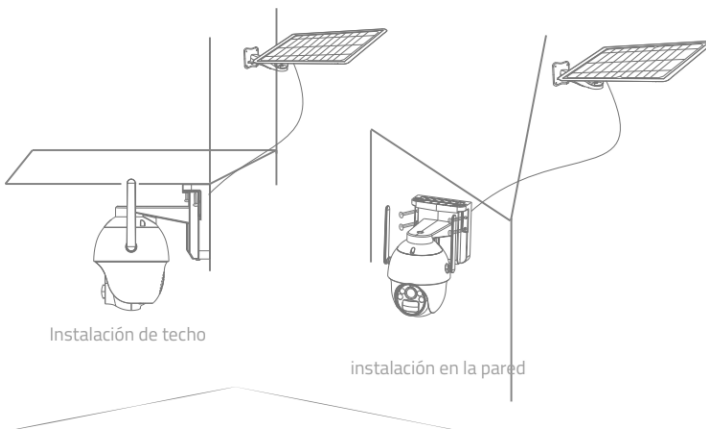

### Pole Mounting

- 1 Attach the iron plate behind the battery compartment of the dome camera with screws
- 2 Install the camera on the post holding the hoop
- 3 Solar mount installation
- 4 The solar panel is installed outdoors and then connected to the camera.

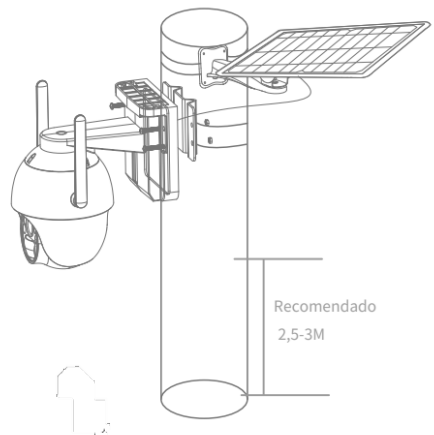

# ADD YOUR CAMERA TO THE MOBILE APPLICATION



## PRO TIP!

Before installing the camera in its final location, first deactivate the PIN code on the SIM card before inserting it into the camera. To do this, you must place the SIM card in a cell phone and access the cell phone settings and look for the section concerning the SIM card

- 1 Download the Eseecloud app on your mobile or tablet



- 2 Register in the Eseecloud app to create a new user account or log in if you have already registered.

- 3 Click on the  icon and select "Scan QR Code".

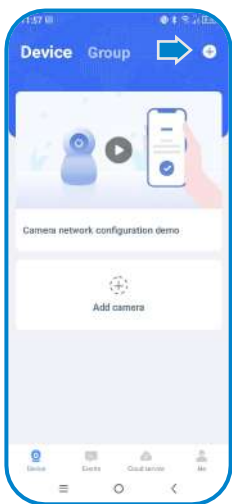
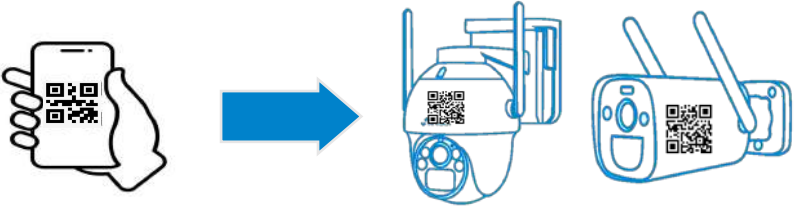

- 4 Follow the application prompts step by step. The camera has been successfully added to the Eseecloud app.

# ADD YOUR CAMERA TO THE MOBILE APPLICATION MANUAL APN CONFIGURATION

- 1 Download the Eseecloud app on your mobile or tablet.
- 2 Register on the Eseecloud app to create a new user account or log in if you have already registered.
- 3 Press the  icon and select "Scan QR Code".

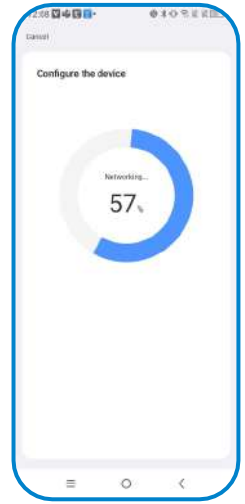
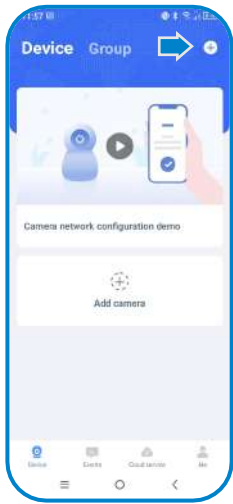

- 4 Press the "APN Settings" button, then enter the APN data of your mobile operator (APN - Authentication type - User - Password). See the APN data of your operator

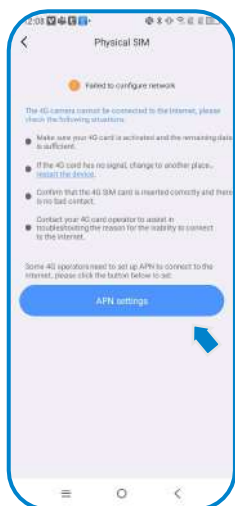

## SETTINGS MENU

- 1 Quick actions menu from the device window
  - Cloud – Cloud recording not available for 4G cameras
  - Events - View the history of detections
  - Share - Share the camera with another user in the app
  - Video Playback – View recorded videos

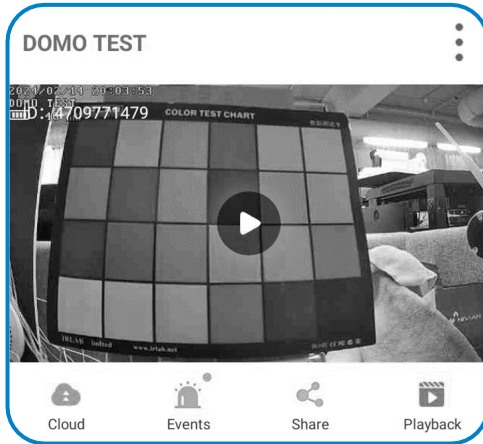

- 2 Press the three dots on the top right corner to access the camera settings menu.
  - Enable notifications - (ON/OFF) Enables notifications in the app
  - Camera settings - General camera settings
  - Edit device name - Type the name for the camera
  - Delete - Delete the camera from the Eseecloud account and from the app

- 3 Press the "Settings" button for more settings

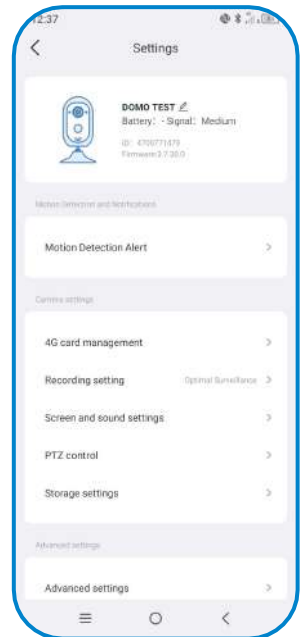
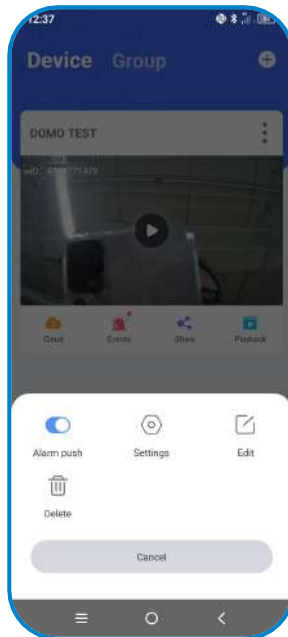
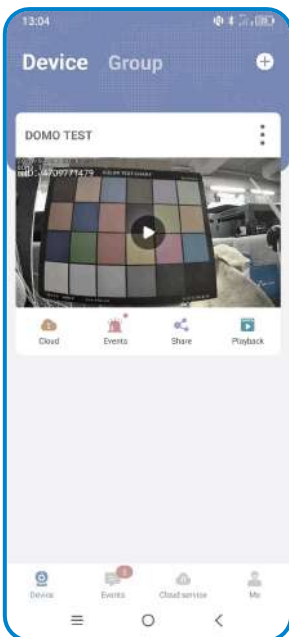

## SETTINGS MENU

1. Motion detection alert
  - 1.1 Motion detection alert (ON/OFF)
  - 1.2 Detection sensitivity (Low / Medium / High)
  - 1.3 Humanoid detection (ON/OFF)
  - 1.4 Motion detection area configuration
  - 1.5 Siren configuration
    - 1.5.1 Siren switch (ON/OFF)
    - 1.5.2 Siren volume
    - 1.5.3 Tone selection (Default / Recording Tone)
2. 4G card management
  - 2.1 SIM card information (signal / ICCID)
3. Recording setting
  - 3.1 Recording mode
    - 3.1.1 Optimal battery life
    - 3.1.2 Optimal surveillance
    - 3.1.3 Uninterrupted recording
  - 3.2 Record only when a human appears (ON/OFF)
  - 3.3 Record sound (ON/OFF)
  - 3.3 Sound recording (ON/OFF)
4. Screen and sound settings
  - 4.1 Night vision mode
    - 4.1.1 Full color night vision
    - 4.1.2 Infrared night vision
  - 4.2 Reverses image (ON/OFF)
  - 4.3 Device call volume
  - 4.4 Privacy area
5. PTZ Control
  - 5.1 PTZ speed (Low / Medium / High)
  - 5.2 PTZ Calibration
  - 5.3 PTZ Control Direction Change
6. Storage settings
  - 6.1 Local storage
  - 6.2 Download local video files
  - 6.3 Format memory card
    - 6.3.1 Formatting
7. Advanced settings
  - 7.1 Status indicator (LED)
  - 7.2 Device message
  - 7.3 Signal strength
  - 7.4 Time synchronization
  - 7.5 Time zone setting
  - 7.6 Daylight saving time (ON/OFF)
  - 7.7 Configuration password
  - 7.8 Restarting the camera
  - 7.9 Deleting and restarting the camera

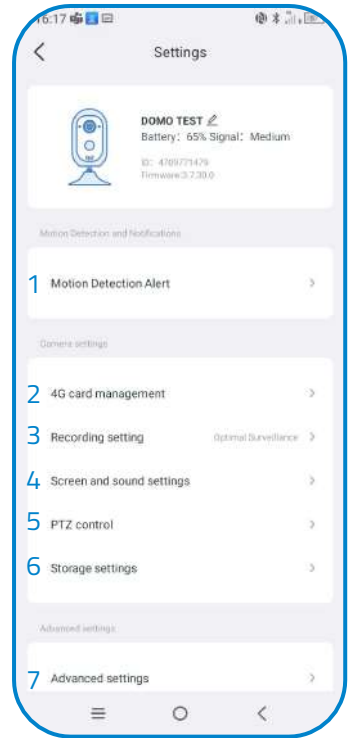



## RISK INFORMATION



Keep the product away from heat sources and flammable products. Do not cover the product during operation. Do not apply aggressive or corrosive products on the product.



Check that your electrical installation complies with current regulations. A faulty installation can cause failures and even fires. Do not use power supplies or cables in poor condition.



Do not manipulate, apply pressure or disassemble the equipment. This voids the warranty and there is a risk of electric shock. If the equipment does not work properly, smoke, suspicious odor or noise appears, disconnect the power supply and contact customer service.



This product, its accessories and packaging are not a toy. Keep them away from children, people or animals to whom they may pose a risk.

## DECLARATION OF COMPLIANCE



This product is manufactured in P.R.C.



This product and the accessories supplied, COMPLY WITH THE applicable harmonized EUROPEAN STANDARDS listed in the Directives: 2014/53/EU for radio equipment, 2014/30/EU for CE, 2011/65/EU for RoHS, 2012/19/EU for WEEE and 2006/66/EC for batteries (where applicable), as well as the rest of the directives indicated in the DECLARATION OF CONFORMITY of the product.



All company, brand and product names are registered trademarks of their respective companies. ©2018 Long Xian Import Export S.L. All rights reserved.



Products marked with this WEEE symbol cannot be disposed of as unsorted municipal waste in the European Union. For PROPER RECYCLING, please dispose of the product and any batteries at designated collection points.



## KAMERABESCHREIBUNG

Notiz:

- 1 Schließen Sie die Kamera an das Solarpanel an und vergewissern Sie sich, dass der Solarpanel-Schalter eingeschaltet ist
- 2 Schalten Sie den Kameraschalter ein.
- 3 Stellen Sie den Solarpanel-Schalter zum Einschalten auf „ON“ und zum Ausschalten auf „OFF“..

### NV-CAM01-SOLAR 4G

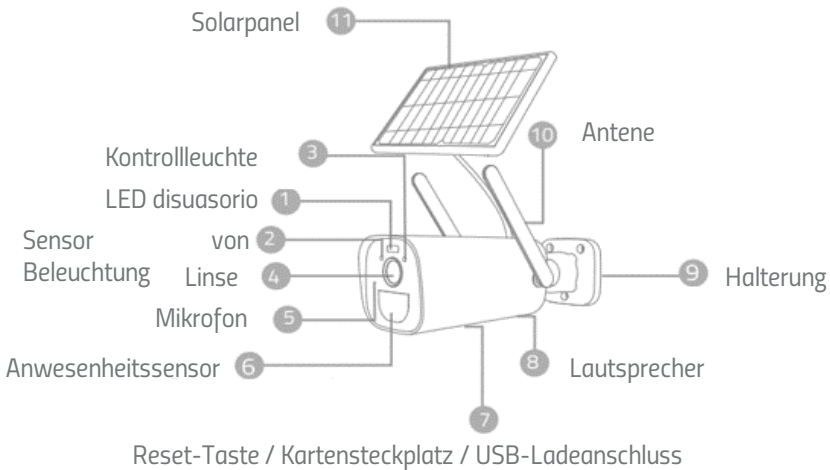

### NV-CAM02S-SOLAR 4G

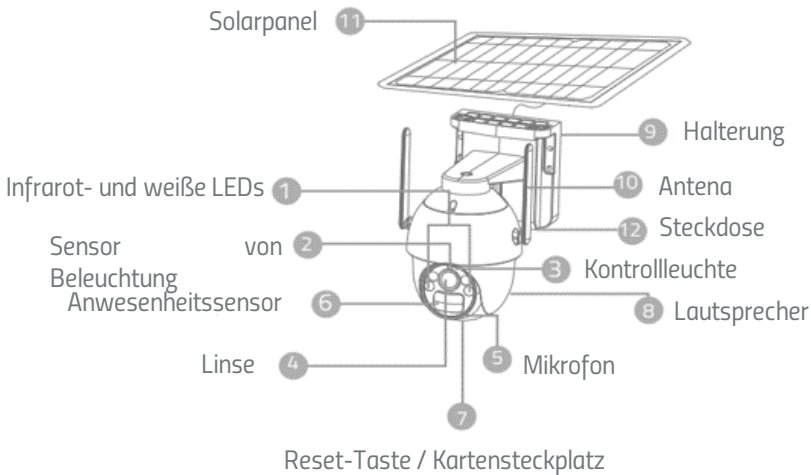

## TIPPS ZUR INSTALLATION

Der PIR-Anwesenheitssensor reagiert empfindlich auf Hitze- und Kältestörungen, bitte beachten Sie folgendes:

Vermeiden Sie es, die Kammer dort zu installieren, wo der Luftstrom bewegt wird. Zum Beispiel: der Luftauslass der Klimaanlage, die Wärmeableitungsöffnung des Geräts, die Seite des Ventilators, die Nähe des Vorhangs usw. Installieren Sie die Kamera nicht vor Glas oder Spiegel. Die Höhe der Kamerainstallation sollte 2,5 m bis 3 m betragen, der beste Abstand zum PIR-Auslöser. Installieren Sie die Kamera nicht verkehrt herum.

### Decken-/Wandmontage

- 1 Verwenden Sie das Installationspapier, um Löcher zu bohren, und die Zementwand sollte in den Gummistopfen genagelt werden.
- 2 Einbau der Kamerabasis.
- 3 Installation von Solarunterstützung.
- 4 Das Solarpanel wird im Freien installiert und dann mit der Kamera verbunden.

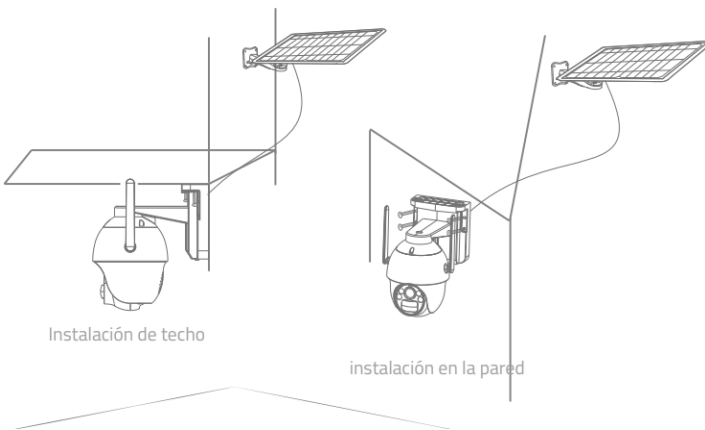

### Montage des Mastes

- 1 Befestigen Sie die Eisenplatte hinter dem Batteriefach der Dome-Kamera mit Schrauben.
- 2 Montieren Sie die Kamera an der Stange, indem Sie den Reifen einklemmen.
- 3 Installation der Solarhalterung.
- 4 Das Solarpanel wird im Freien installiert und dann mit der Kamera verbunden.

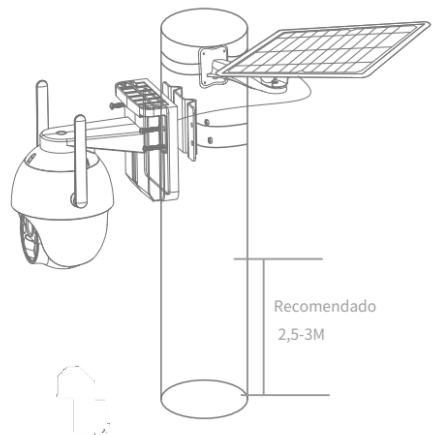

# FÜGEN SIE IHRE KAMERA ZUR MOBILEN APP HINZU

## PROFI-TIPP!



Bevor Sie die Kamera an ihrem endgültigen Platz installieren, deaktivieren Sie zunächst den PIN-Code auf der SIM-Karte, bevor Sie sie in die Kamera einsetzen. Dazu müssen Sie die SIM-Karte in ein Mobiltelefon einlegen und auf die Einstellungen des Mobiltelefons zugreifen und nach dem Abschnitt suchen, der sich auf die SIM-Karte bezieht

Laden Sie die Eseecloud-App auf Ihr Handy oder Tablet herunter.



2 Registrieren Sie sich in der Eseecloud-App, um ein neues Benutzerkonto zu erstellen, oder melden Sie sich an, wenn Sie sich bereits registriert haben.

3 Tippen Sie auf  und wählen Sie "QR-Code scannen".

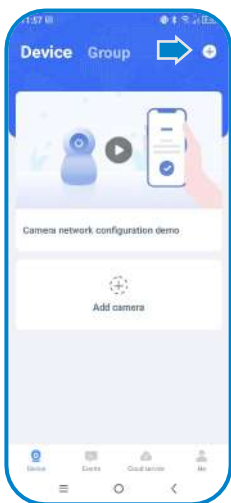

4 Folgen Sie den Anweisungen in der App Schritt für Schritt. Die Kamera wurde erfolgreich zur Eseecloud-App hinzugefügt.

# FÜGEN SIE IHRE KAMERA ZUR MOBILEN APP HINZU MANUELLE APN-KONFIGURATION

- 1 Laden Sie die Eseecloud-App auf Ihr Handy oder Tablet herunter.
- 2 Registrieren Sie sich in der Eseecloud-App, um ein neues Benutzerkonto zu erstellen, oder melden Sie sich an, wenn Sie sich bereits registriert haben.
- 3 Tippen Sie auf  und wählen Sie "QR-Code scannen".

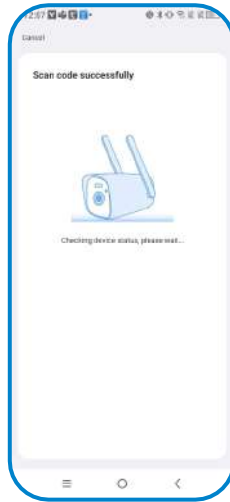
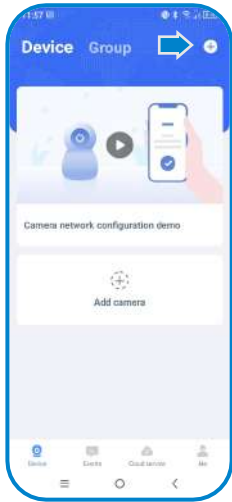

- 4 Klicken Sie auf die Schaltfläche "APN-Einstellungen" und geben Sie dann die APN-Daten Ihres Mobilfunkanbieters ein (APN – Authentifizierungstyp – Benutzername – Passwort).  
Überprüfen Sie die APN-Daten Ihres Mobilfunkanbieters.

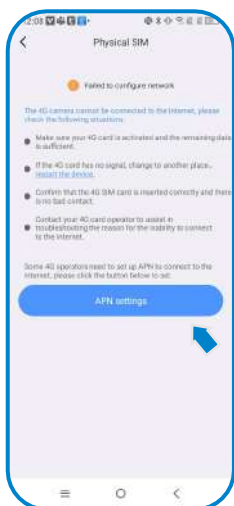

## ANGEPASSTES MENÜ

- Menü "Schnellaktionen" im Gerätefenster.
  - Cloud - Cloud-Aufzeichnung für 4G-Kameras nicht verfügbar.
  - Ereignisse: Zeigen Sie den Verlauf der Erkennungen an.
  - Freigeben - Ermöglicht es Ihnen, Ihre Kamera mit einem anderen Benutzer in der App zu teilen.
  - Videowiedergabe - Anzeigen der aufgenommenen Videos.

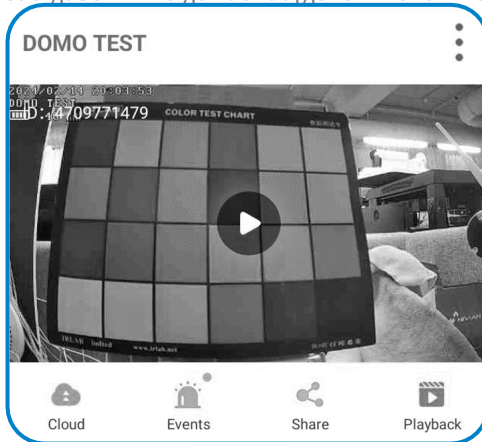

- Tippen Sie auf die "drei Punkte", um das Einstellungs Menü der Kamera aufzurufen.
  - Benachrichtigungen aktivieren-(EIN/AUS) Aktivieren Sie Benachrichtigungen in der App.
  - Kameraeinstellungen - Allgemeine Kameraeinstellungen.
  - Gerätename bearbeiten - Geben Sie den Namen für die Kamera ein.
  - Löschen - Löschen Sie die Kamera aus dem Eseecloud-Konto und der App.

- Klicken Sie auf die Schaltfläche "Einstellungen", um weitere Einstellungen vorzunehmen

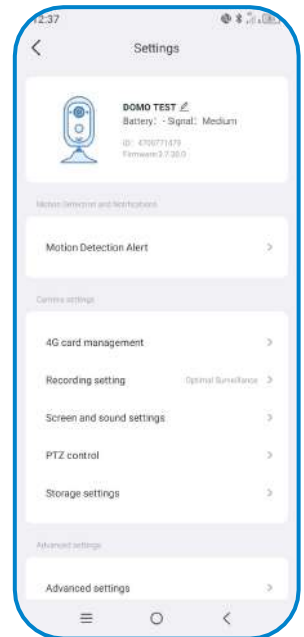
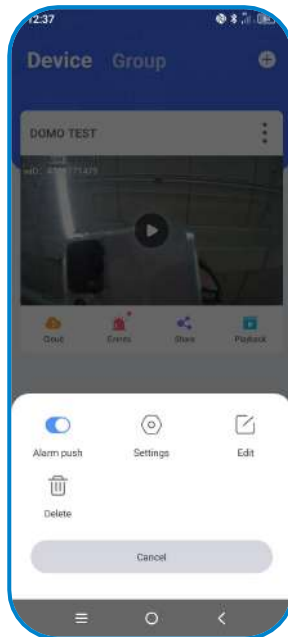
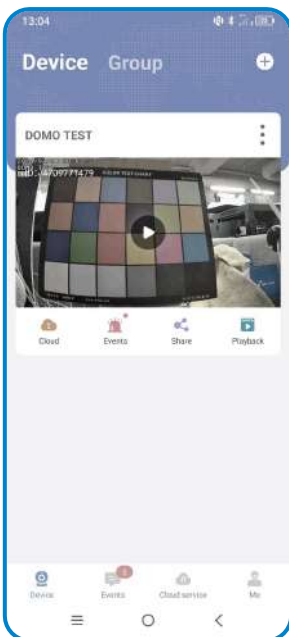

# ANGEPASSTES MENÜ

1. Bewegungserkennungs-Warnung
  - 1.1 Bewegungserkennungsalarm (EIN/AUS)
  - 1.2 Detektionsempfindlichkeit (niedrig/mittel/hoch)
  - 1.3 Humanoide Erkennung (EIN/AUS)
  - 1.4 Konfigurieren des Bewegungserkennungsbereichs
  - 1.5 Konfiguration der Sirene
    - 1.5.1 Sirenschalter (EIN/AUS)
    - 1.5.2 Meerjungfrauen-Lautstärke
    - 1.5.3 Tonhöhenauswahl (Standard / Aufnahme-ton)
2. Verwaltung von 4G-Karten
  - 2.1 SIM-Karten-Informationen (Signal/ICCID)
3. Aufnahme-Einstellungen
  - 3.1 Aufnahme-Modus
    - 3.1.1 Optimale Akkulaufzeit
    - 3.1.2 Optimale Überwachung
    - 3.1.3 Ununterbrochene Aufzeichnung
  - 3.2 Nur aufzeichnen, wenn ein Mensch erscheint (EIN/AUS)
  - 3.3 Ton aufnehmen (EIN/AUS)
4. Anzeige- und Toneinstellungen
  - 4.1 Nachtsicht-Modus
    - 4.1.1 Vollfarb-Nachtsicht
    - 4.1.2 Infrarot-Nachtsicht
  - 4.2 Bild invertieren (EIN/AUS)
  - 4.3 Lautstärke der Geräteanrufe
  - 4.4 Datenschutzbereich
5. PTZ-Steuerung
  - 5.1 PTZ-Geschwindigkeit (niedrig/mittel/hoch)
  - 5.2 PTZ-Kalibrierung
  - 5.3 Änderung der PTZ-Steuerrichtung
6. Konfiguration des Speichers
  - 6.1 Lokaler Speicher
  - 6.2 Lokale Videodateien herunterladen
  - 6.3 Speicherkarte formatieren
    - 6.3.1 Formatierung
7. Erweiterte Einstellungen
  - 7.1 Statusanzeige (LED)
  - 7.2 Geräte-Meldung
  - 7.3 Signalstärke
  - 7.4 Zeitsynchronisation
  - 7.5 Zeitzone-Einstellungen
  - 7.6 Sommerzeit (EIN/AUS)
  - 7.7 Konfigurations-Passwort
  - 7.8 Starten Sie die Kamera neu
  - 7.9 Löschen und Neustarten der Kamera

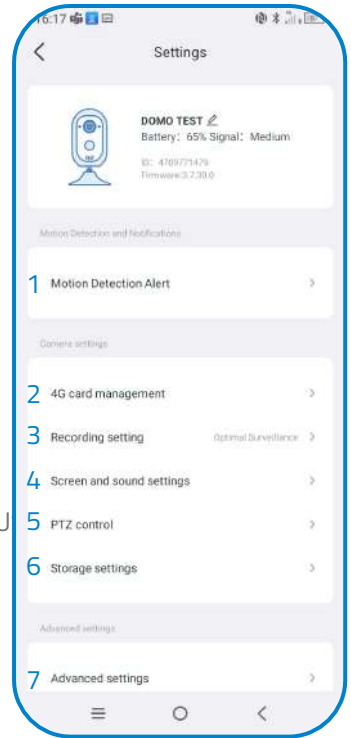

## RISIKO-INFORMATIONEN



Halten Sie das Produkt von Wärmequellen und brennbaren Produkten fern. Decken Sie das Produkt nicht ab, während es einwirkt. Tragen Sie keine aggressiven oder ätzenden Produkte auf das Produkt auf.



Prüfen Sie, ob Ihre Elektroinstallation den geltenden Vorschriften entspricht. Eine unsachgemäße Installation kann zu Ausfällen und sogar Bränden führen. Verwenden Sie keine Netzteile oder Kabel, die sich in einem schlechten Zustand befinden.



Fassen Sie das Gerät nicht an, setzen Sie es nicht unter Druck und zerlegen Sie es nicht. Dadurch erlischt die Garantie und es besteht die Gefahr eines Stromschlags. Wenn Ihr Computer nicht richtig funktioniert, Rauch, verdächtiger Geruch oder Lärm aufweist, trennen Sie das Gerät vom Stromnetz und wenden Sie sich an den Kundendienst.



Dieses Produkt, sein Zubehör und die entsprechende Verpackung sind kein Spielzeug. Halten Sie sie von Kindern, Menschen oder Tieren fern, für die sie eine Gefahr darstellen könnten.

## KONFORMITÄTSERKLÄRUNG



Hergestellt in P.R.C.



Dieses Produkt und das mitgelieferte Zubehör, ENTSPRECHEN SIE DEN GELTENDEN HARMONISIERTEN EUROPÄISCHEN NORMEN, die in den Richtlinien 2014/53/EU für Funkanlagen, 2014/30/EU für CE, 2011/65/EU für RoHS, 2012/19/EU für Elektro- und Elektronik-Altgeräte und 2006/66/EG für Batterien (falls zutreffend) aufgeführt sind, sowie in den übrigen Richtlinien, die in der KONFORMITÄTSERKLÄRUNG des Produkts angegeben sind.



Alle Firmen-, Marken- und Produktnamen sind eingetragene Warenzeichen der jeweiligen Unternehmen.

©Lieferant:2018 Long Xian Import Export Co., Ltd. Alle Rechte vorbehalten.



Produkte, die mit diesem WEEE-Symbol gekennzeichnet sind, dürfen in der Europäischen Union nicht als nicht klassifizierter Siedlungsabfall entsorgt werden. Für ein ORDNUNGSGEMÄSSES RECYCLING entsorgen Sie bitte das Produkt und alle Batterien an ausgewiesenen Sammelstellen.



## DESCRIPTION DE LA CAMÉRA

Remarque :

- 1 Connectez la caméra au panneau solaire et vérifiez que l'interrupteur du panneau solaire est allumé.
- 2 Allumez l'interrupteur de la caméra
- 3 Positionnez l'interrupteur du panneau solaire sur "ON" pour l'allumer et sur "OFF" pour l'éteindre.

### NV-CAM01-SOLAR 4G

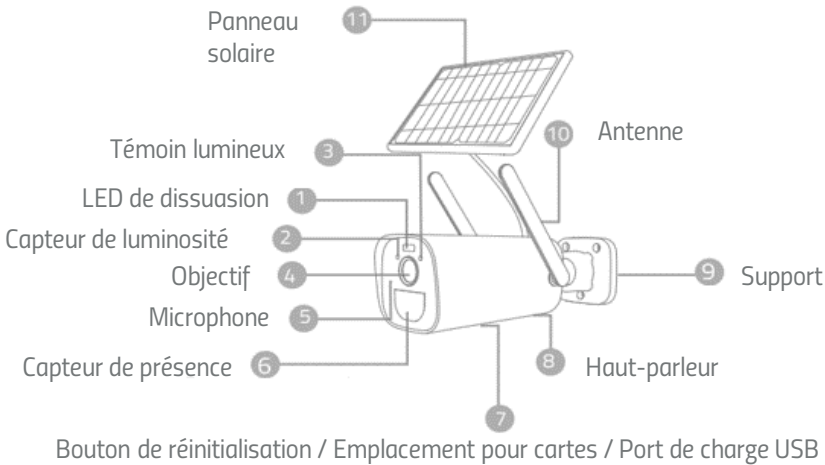

### NV-CAM02S-SOLAR 4G

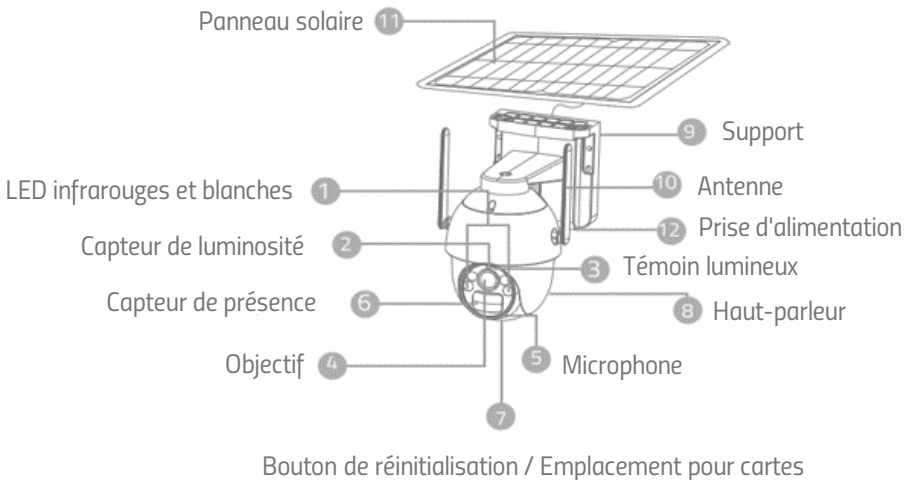

## CONSEILS D'INSTALLATION

Le capteur de présence PIR est sensible aux perturbations dues à la chaleur et au froid :

Évitez d'installer la caméra dans un endroit où le flux d'air est agité. Par exemple : la sortie d'air du climatiseur, le port de dissipation de chaleur du dispositif, à côté du ventilateur, à proximité du rideau, etc. N'installez pas la caméra devant une vitre ou un miroir. **La hauteur d'installation de la caméra doit être comprise entre 2,5 et 3 mètres, ce qui correspond à la meilleure distance par rapport au déclencheur PIR.** N'installez pas la caméra à l'envers.

### Installation au plafond/mur

- 1 Utilisez le gabarit en papier pour percer les trous dans le mur, puis insérez les chevilles en caoutchouc et procédez à l'installation.
- 2 Installation de la base de la caméra.
- 3 Installation du support solaire.
- 4 Le panneau solaire s'installe à l'extérieur, puis il est connecté à la caméra.

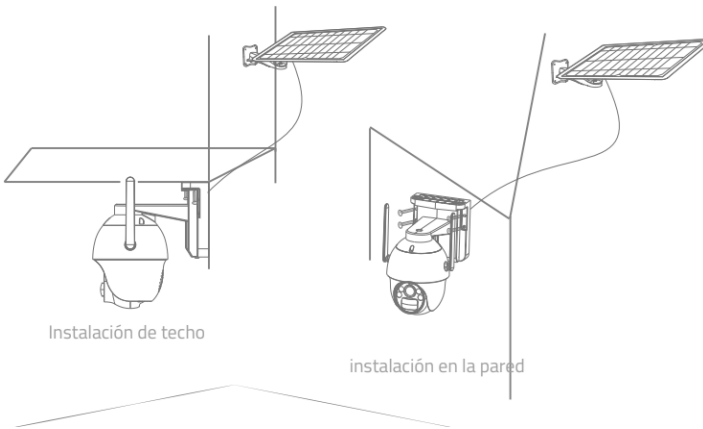

### Installation du mât

- 1 Fixez la plaque de fer derrière le compartiment à piles de la caméra dôme à l'aide de vis.
- 2 Installez la caméra sur le mât en fixant l'anneau.
- 3 Installation du support solaire.
- 4 Le panneau solaire s'installe à l'extérieur puis il est connecté à la caméra.

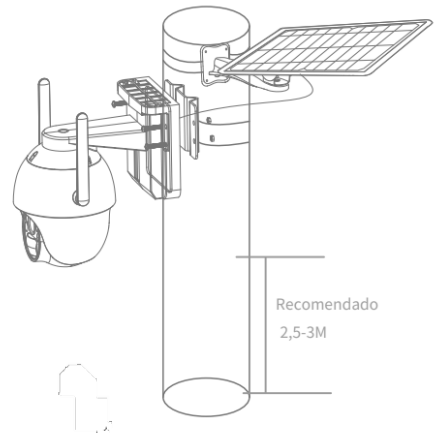

# AJOUTEZ VOTRE CAMÉRA À L'APPLICATION MOBILE



## CONSEIL DE PRO !

Avant d'installer la caméra à son emplacement définitif, il faut d'abord désactiver le code PIN de la carte SIM avant de l'insérer dans la caméra. Pour ce faire, vous devez placer la carte SIM dans un téléphone portable et vous rendre dans les paramètres du téléphone et chercher la section concernant la carte SIM.

- 1 Téléchargez l'application Eseecloud sur votre téléphone portable ou votre tablette.



- 2 Inscrivez-vous sur l'application Eseecloud pour créer un nouveau compte utilisateur ou connectez-vous si vous êtes déjà inscrit.

- 3 Cliquez sur l'icône **+** et sélectionnez "Scanner le code QR".

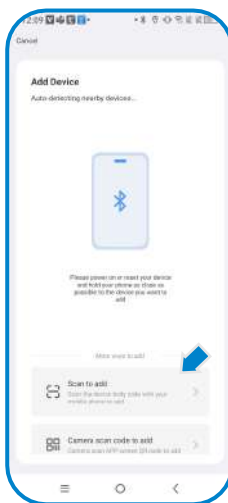
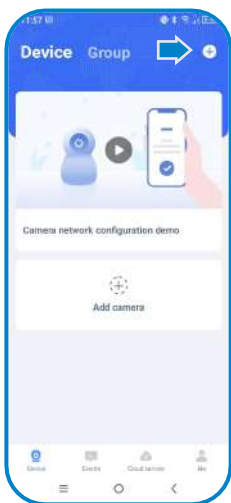
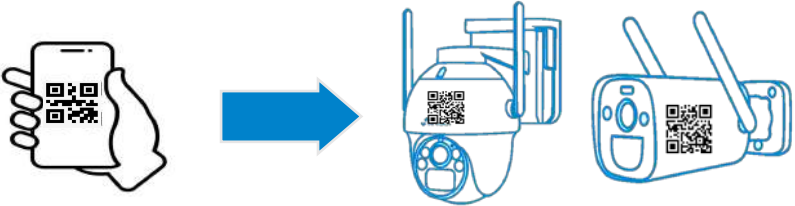

- 4 Suivez les instructions étape par étape dans l'application. La caméra a été ajoutée avec succès à l'application Eseecloud.

# AJOUTEZ VOTRE CAMÉRA À L'APPLICATION MOBILE CONFIGURATION MANUELLE DE L'APN

- 1 Téléchargez l'application Eseecloud sur votre téléphone portable ou votre tablette.
- 2 Inscrivez-vous sur l'application Eseecloud pour créer un nouveau compte utilisateur ou connectez-vous si vous êtes déjà inscrit.
- 3 Cliquez sur l'icône  et sélectionnez "Scanner le code QR".

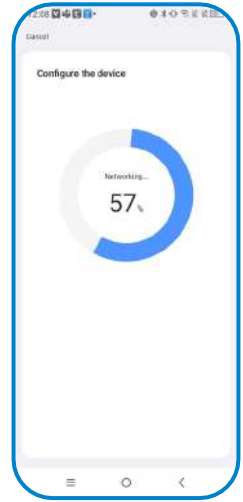
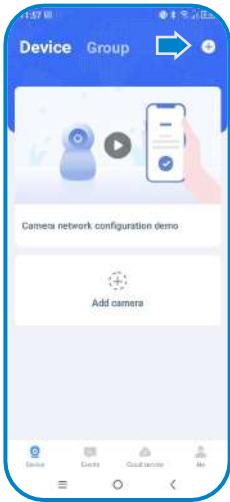

- 4 Appuyez sur le bouton "Paramètres APN", puis entrez les données APN de votre opérateur mobile (APN - Type d'authentification - Utilisateur - Mot de passe). Voir les données APN de votre opérateur

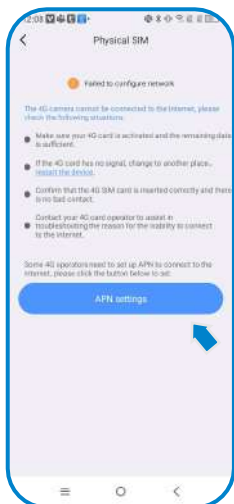

## MENU DES RÉGLAGES

- Menu d'actions rapides depuis la fenêtre du dispositif

  - Cloud - L'enregistrement dans le cloud n'est pas disponible pour les caméras 4G.
  - Événements- Permet d'afficher l'historique des détections
  - Partager- Permet de partager la caméra avec un autre utilisateur dans l'application.
  - Lecture de vidéos- Visualisation des vidéos enregistrées

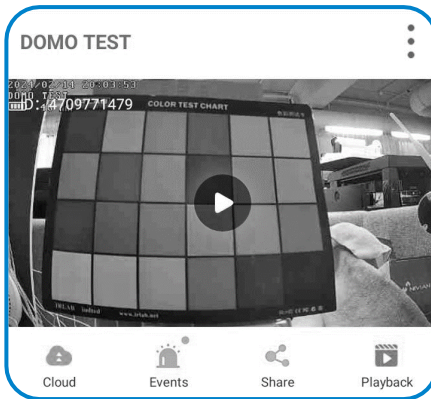

- Appuyez sur les "trois points" pour accéder au menu des paramètres de la caméra.

  - Activer les notifications - (ON/OFF) Activez les notifications dans l'application.
  - Paramètres de la caméra - Paramètres généraux de la caméra
  - Modifier le nom du dispositif- Saisissez le nom de la caméra
  - Supprimer - Supprimez la caméra du compte Eseecloud et de l'application

- Appuyez sur le bouton "Réglages" pour plus de détails

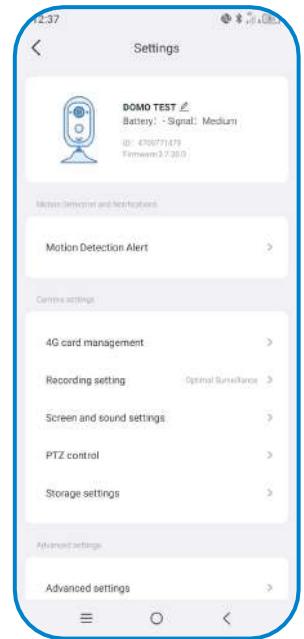
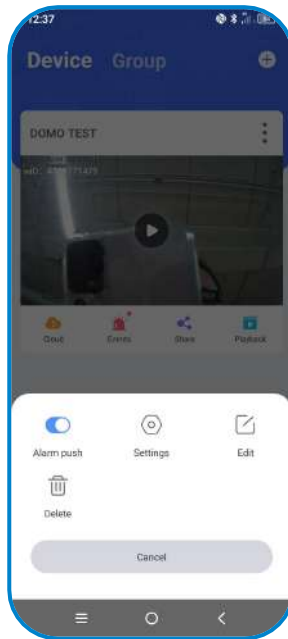
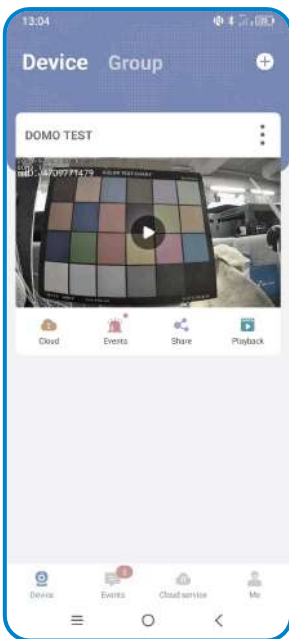

# MENU RÉGLAGES

1. Alerte de détection de mouvement
  - 1.1 Alerte de détection de mouvement (ON/OFF)
  - 1.2 Sensibilité de la détection (faible / moyenne / élevée)
  - 1.3 Détection de personnes (ON/OFF)
  - 1.4 Configuration de la zone de détection de mouvement
  - 1.5 Configuration de la sirène
    - 1.5.1 Interrupteur de la sirène (ON/OFF)
    - 1.5.2 Volume de la sirène
    - 1.5.3 Sélection de la tonalité (par défaut / tonalité d'enregistrement)
2. Gestion des cartes 4G
  - 2.1 Informations sur la carte SIM (signal / ICCID)
3. Configuration de l'enregistrement
  - 3.1 Mode d'enregistrement
    - 3.1.1 Durée d'autonomie optimale de la batterie
    - 3.1.2 Surveillance optimale
    - 3.1.3 Enregistrement ininterrompu
  - 3.2 Enregistrement uniquement lorsqu'une personne apparaît
  - 3.3 Enregistrement du son (ON/OFF)
4. Configuration de l'écran et du son
  - 4.1 Mode de vision nocturne
    - 4.1.1 Vision nocturne en couleurs
    - 4.1.2 Vision nocturne infrarouge
  - 4.2 Inversion de l'image (ON/OFF)
  - 4.3 Volume d'appel du dispositif
  - 4.4 Zone de confidentialité
5. Contrôle PTZ
  - 5.1 Vitesse PTZ (Faible / Moyenne / Élevée)
  - 5.2 Calibrage du PTZ
  - 5.3 Changement de direction du contrôle PTZ
6. Configuration du stockage
  - 6.1 Stockage local
  - 6.2 Téléchargement de fichiers vidéo locaux
  - 6.3 Formatage de la carte mémoire
    - 6.3.1 Formatage
7. Paramètres avancés
  - 7.1 Indicateur d'état (LED)
  - 7.2 Message du dispositif
  - 7.3 Performance du signal
  - 7.4 Synchronisation de l'heure
  - 7.5 Réglage du fuseau horaire
  - 7.6 Heure d'été (ON/OFF)
  - 7.7 Mot de passe de configuration
  - 7.8 Redémarrage de la caméra
  - 7.9 Effacer et redémarrer la caméra

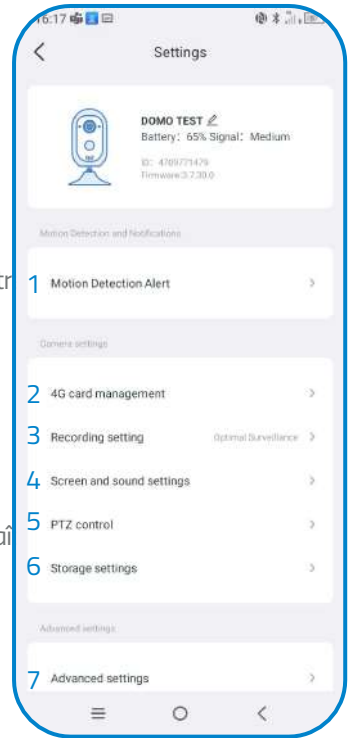

## INFORMATIONS SUR LES RISQUES



Tenir le dispositif à l'écart des sources de chaleur et des produits inflammables. Ne pas couvrir le produit pendant son fonctionnement. Ne pas appliquer de produits agressifs ou corrosifs sur le dispositif.



Vérifiez que votre installation électrique est conforme aux normes en vigueur. Une installation non conforme peut être à l'origine de pannes, voire d'incendies. Ne pas utiliser de blocs d'alimentation ou de câbles en mauvais état.



Ne pas manipuler, exercer une pression ou démonter l'appareil. Cela annule la garantie et il existe un risque d'électrocution. Si le dispositif ne fonctionne pas correctement, s'il y a de la fumée, une odeur suspecte ou un bruit, débranchez l'alimentation électrique et contactez le service client.



Ce produit, ses accessoires et les emballages respectifs ne sont pas des jouets. Tenez-les hors de portée des enfants et des personnes ou des animaux pour lesquels ils peuvent représenter un danger.

## DÉCLARATION DE CONFORMITÉ



Produit fabriqué en R.P.C. (Chine)



Ce produit et les accessoires fournis sont conformes aux normes européennes harmonisées applicables, telles qu'elles figurent dans les directives suivantes : 2014/53/UE pour les appareils radioélectriques, 2014/30/UE pour la CE, 2011/65/UE pour la RoHS, 2012/19/UE pour la DEEE et 2006/66/CE pour les batteries (le cas échéant), ainsi que les autres directives énumérées dans la DÉCLARATION DE CONFORMITÉ du produit.



Tous les noms de sociétés, de marques et de produits sont des marques déposées de leurs sociétés respectives. ©2018 Long Xian Import Export S.L. Tous droits réservés.



Les produits marqués de ce symbole DEEE ne peuvent pas être jetés comme des déchets municipaux non triés dans l'Union européenne. Pour un RECYCLAGE APPROPRIÉ, veuillez déposer le produit et les piles/batteries éventuelles dans les points de collecte prévus à cet effet.



## DESCRIZIONE DELLA TELECAMERA

Nota:

- 1 Collegare la telecamera al pannello solare e verificare che l'interruttore del pannello solare sia acceso.
- 2 Accendere la telecamera.
- 3 Impostare il pulsante del pannello solare su "ON" per accenderlo e su "OFF" per spegnerlo.

### NV-CAM01-SOLAR 4G

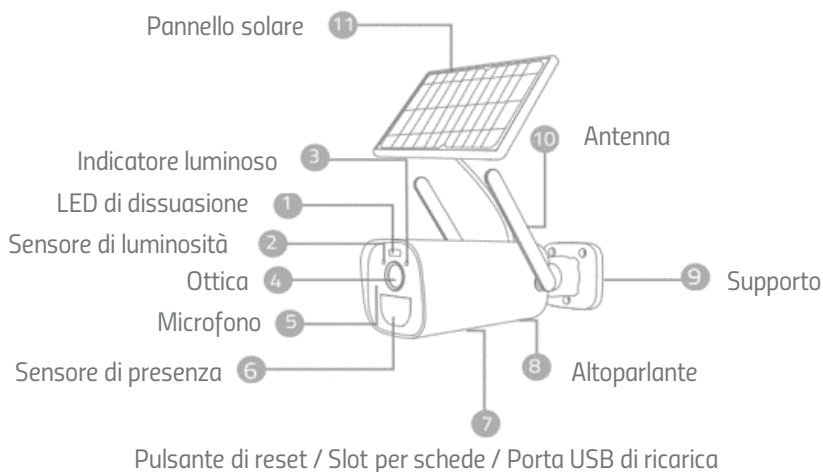

### NV-CAM02S-SOLAR 4G

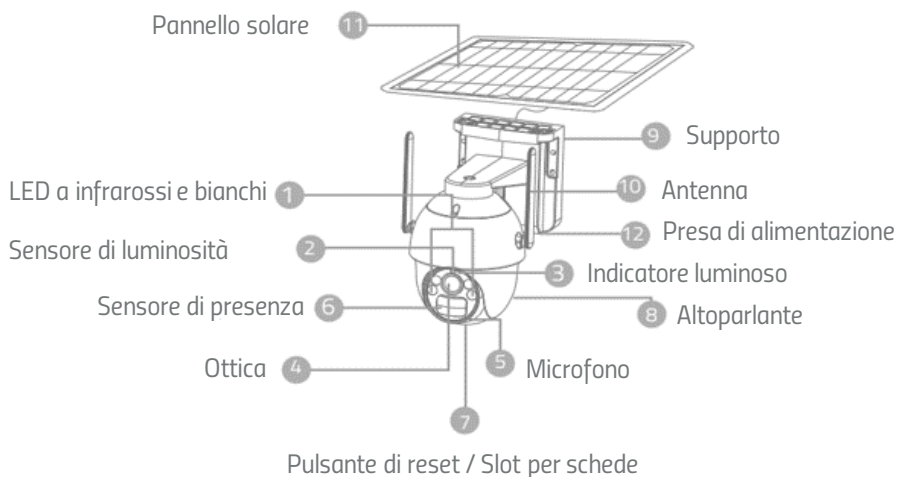

## CONSIGLI PER L'INSTALLAZIONE

Il sensore di presenza PIR è sensibile ai disturbi legati al calore e al freddo; tenere presente quanto segue:

Evitare di installare la telecamera in un punto in cui il flusso d'aria è soggetto al movimento. Ad esempio: l'uscita dell'aria del condizionatore, la porta di dissipazione del calore dell'apparecchiatura, vicino ad un ventilatore o una tenda, ecc. Non installare la telecamera davanti a vetri o specchi. **L'altezza di installazione della telecamera deve essere compresa tra i 2,5 e i 3 metri.** Non installare la telecamera capovolta.

### Installazione a soffitto/parete

- 1 Utilizzare il modello in carta per praticare i fori nella parete, quindi inserire i tappi di gomma ed eseguire l'installazione.
- 2 Installazione della base della telecamera.
- 3 Installazione del supporto solare.
- 4 Il pannello solare viene installato all'esterno e poi collegato alla telecamera.

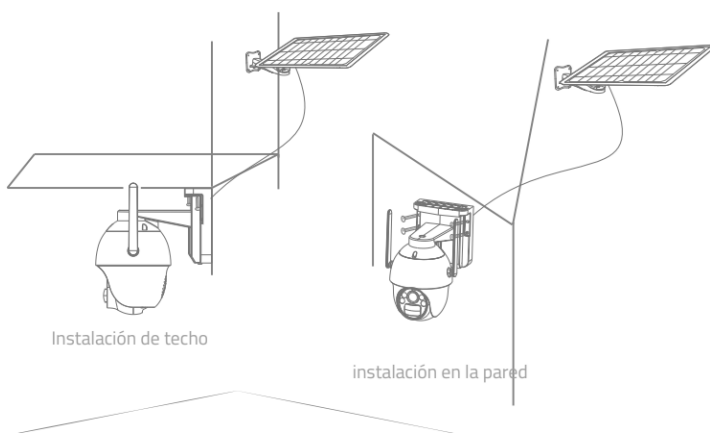

### Installazione del palo

- 1 Fissare la piastra di ferro dietro il vano batteria della telecamera dome con delle viti.
- 2 Installare la telecamera sul palo fissando la ghiera.
- 3 Installare il pannello solare.
- 4 Il pannello solare viene installato all'esterno e poi collegato alla telecamera.

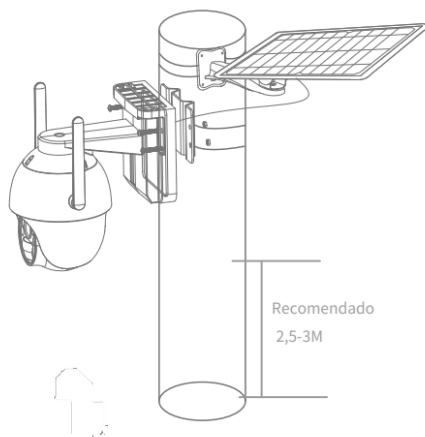

# AGGIUNGERE LA TELECAMERA ALL'APP MOBILE



## CONSIGLIO PROFESSIONALE!

Prima di installare la telecamera nella sua posizione definitiva, disattivare il codice PIN della scheda SIM prima di inserirla nella telecamera. A tal fine, inserire la scheda SIM in un telefono cellulare e accedere alle impostazioni del telefono cellulare, cercando la sezione relativa alla

- 1 Scaricare l'app Eseecloud sul proprio cellulare o tablet.



- 2 Registrarsi nell'app Eseecloud per creare un nuovo account utente o accedere se si è già registrati.

- 3 Pulsare su  e selezionare "Scansione del codice QR".

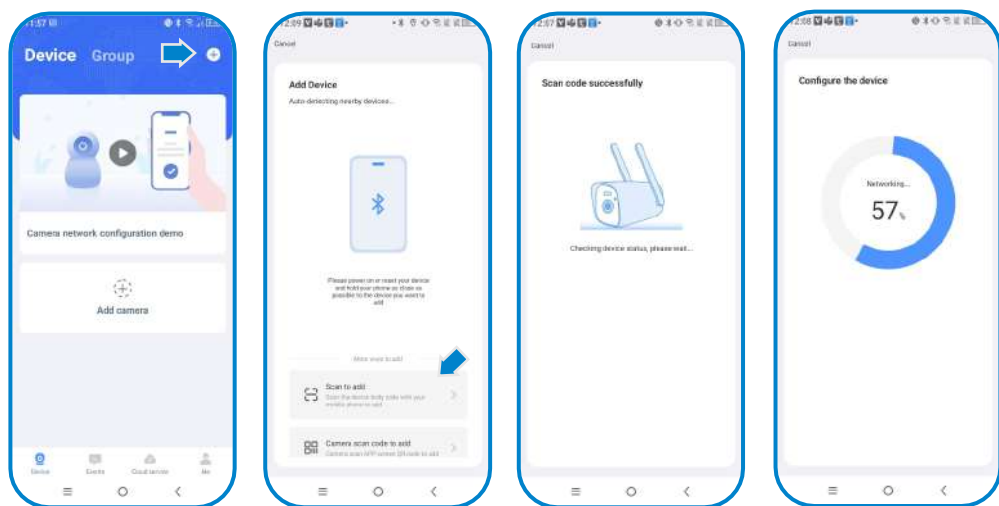
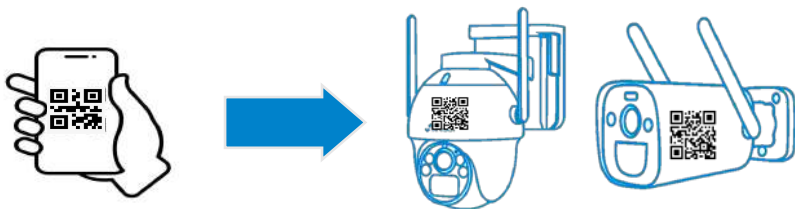

- 4 Seguire le istruzioni passo-passo contenute nell'app. La telecamera è stata aggiunta con successo all'app Eseecloud.

# AGGIUNGERE LA TELECAMERA ALL'APP MOBILE CONFIGURAZIONE MANUALE DELL'APN

- 1 Scaricare l'app Eseecloud sul proprio cellulare o tablet.
- 2 Registrarsi nell'app Eseecloud per creare un nuovo account utente o accedere se si è già registrati.
- 3 Pulsare su  e selezionare "Scansione del codice QR".

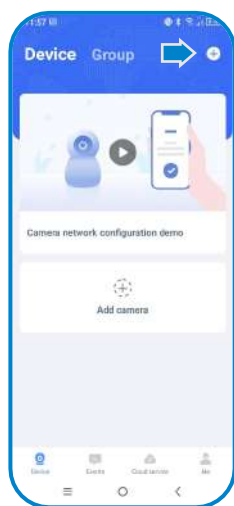

- 4 Premere il pulsante "Impostazioni APN", quindi inserire i dati APN del proprio operatore mobile (APN - Tipo di autenticazione - Utente - Password). Consultare i dati APN del proprio operatore.

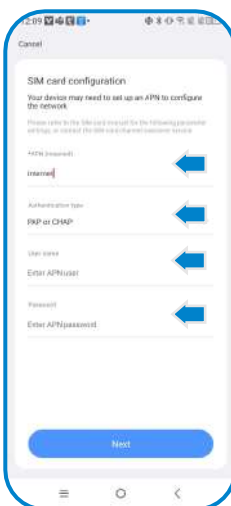
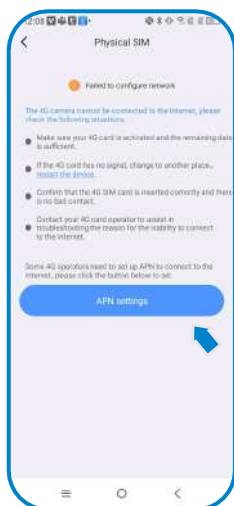

## MENU IMPOSTAZIONI

### 1 Menu dalla finestra del dispositivo

- Cloud - La registrazione su cloud non è disponibile per le telecamere 4G
- Eventi – Visualizzazione della cronologia dei rilevamenti
- Condivisione - Consente di condividere la telecamera con un altro utente dell'app
- Riproduzione video – Visualizzazione dei video registrati

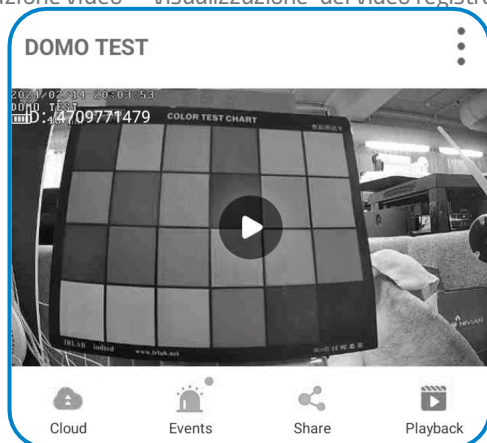

### 2 Premere i "tre punti" per accedere al menu delle impostazioni della telecamera

- Attiva notifiche - (ON/OFF) Attiva le notifiche nell'app
- Impostazioni telecamera - Impostazioni generali della telecamera
- Modifica nome dispositivo - Inserire il nome della telecamera
- Elimina - Elimina la telecamera dall'account Eseecloud e dall'app

### 3 Premere il pulsante "Impostazioni" per ulteriori impostazioni

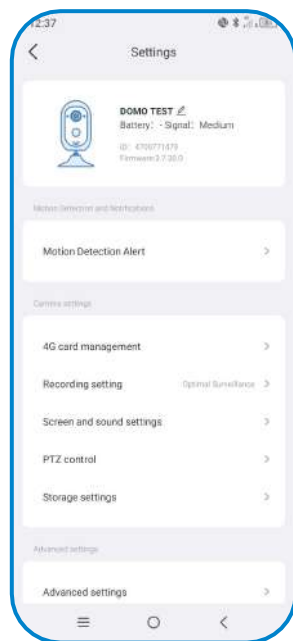
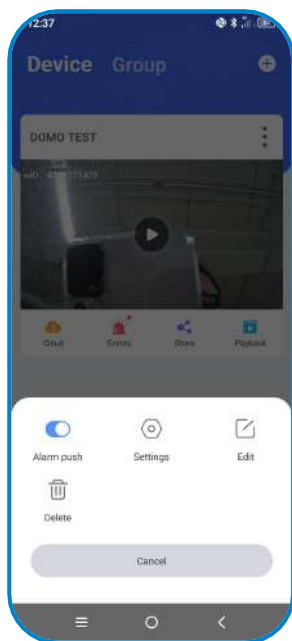
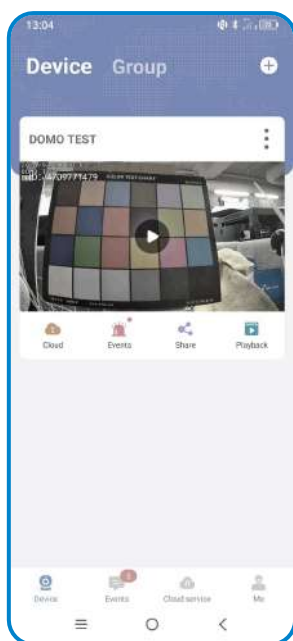

## MENU IMPOSTAZIONI

1. Allarme di rilevamento del movimento
  - 1.1 Allarme di rilevamento del movimento (ON/OFF)
  - 1.2 Sensibilità di rilevamento ( Bassa / Media / Alta)
  - 1.3 Rilevamento di persone (ON/OFF)
  - 1.4 Configurazione area di rilevamento del movimento
  - 1.5 Configurazione della sirena
    - 1.5.1 Pulsante della sirena (ON/OFF)
    - 1.5.2 Volume della sirena
    - 1.5.3 Selezione tono (Predefinito / Tono di registrazione)
2. Gestione schede 4G
  - 2.1 Informazioni sulla scheda SIM (segnale / ICCID)
3. Configurazione della registrazione
  - 3.1 Modalità di registrazione
    - 3.1.1 Durata ottimale della batteria
    - 3.1.2 Videosorveglianza di qualità
    - 3.1.3 Registrazione ininterrotta
  - 3.2 Registrazione solo in presenza di persone (ON/OFF)
  - 3.3 Registrazione del suono (ON/OFF)
4. Impostazioni dello schermo e del suono
  - 4.1 Modalità di visione notturna
    - 4.1.1 Visione notturna a colori
    - 4.1.2 Visione notturna a infrarossi
  - 4.2 Capovolgì immagine (ON/OFF)
  - 4.3 Volume delle chiamate del dispositivo
  - 4.4 Area privacy
5. Controllo PTZ
  - 5.1 Velocità PTZ ( Bassa / Media / Alta)
  - 5.2 Calibrazione PTZ
  - 5.3 Cambio di direzione del controllo PTZ
6. Configurazione dello storage
  - 6.1 Storage locale
  - 6.2 Download dei file video locali
  - 6.3 Formattazione della scheda di memoria
    - 6.3.1 Formattazione
7. Impostazioni avanzate
  - 7.1 Indicatore di stato (LED)
  - 7.2 Messaggio del dispositivo
  - 7.3 Potenza del segnale
  - 7.4 Sincronizzazione dell'ora
  - 7.5 Impostazione del fuso orario
  - 7.6 Ora legale (ON/OFF)
  - 7.7 Password di configurazione
  - 7.8 Riavvio della telecamera
  - 7.9 Eliminare e riavviare la telecamera

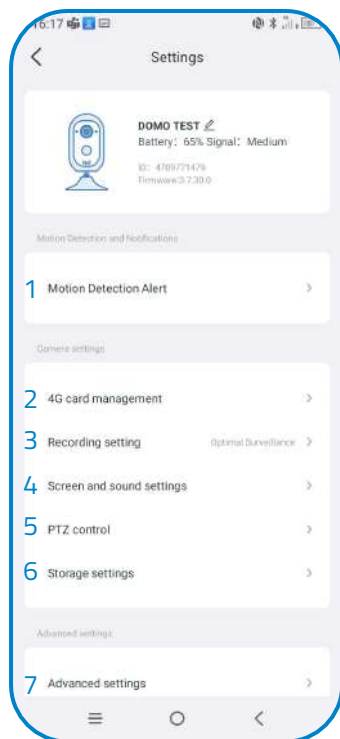

## INFORMAZIONI SUI RISCHI



Tenere il prodotto lontano da fonti di calore e prodotti infiammabili. Non coprire il prodotto durante il funzionamento. Non applicare al prodotto sostanze aggressive o corrosive.



Verificare che l'impianto elettrico sia conforme alle normative vigenti. Un'installazione carente può causare guasti e persino incendi. Non utilizzare alimentatori o cavi in cattive condizioni.



Non manipolare, esercitare pressione o smontare l'apparecchiatura. Ciò invalida la garanzia e comporta il rischio di scosse elettriche. Se l'apparecchiatura non funziona correttamente, se compare fumo, odore sospetto o rumore, scollegare l'alimentazione e contattare il servizio di assistenza clienti.



Questo prodotto, i suoi accessori e la confezione non sono giocattoli. Tenerli lontani da bambini, persone o animali per i quali possono rappresentare un rischio.

## DICHIARAZIONE DI CONFORMITÀ



Prodotto fabbricato in P.R.C.



Questo prodotto e gli accessori forniti sono CONFORMI agli standard europei armonizzati applicabili elencati nelle direttive: 2014/53/UE per le apparecchiature radio, 2014/30/UE per la CE, 2011/65/UE per la RoHS, 2012/19/UE per i RAEE e 2006/66/CE per le batterie (ove applicabile), nonché alle altre direttive elencate nella DICHIARAZIONE DI CONFORMITÀ del prodotto.



Tutti i nomi di società, marchi e prodotti sono marchi registrati delle rispettive società. ©2018 Long Xian Import Export S.L. Tutti i diritti riservati.



I prodotti contrassegnati dal simbolo WEEE non possono essere smaltiti come rifiuti urbani indifferenziati nell'Unione Europea. Per un corretto riciclo, smaltire il prodotto e le eventuali batterie presso i punti di raccolta designati.



## DESCRIPCION DE LA CAMARA

Nota:

- 1 Conecte la cámara al panel solar y confirme que el interruptor del panel solar este encendido
- 2 Encienda el interruptor de la cámara
- 3 Situe el interruptor del panel solar en "ON" para encender y "OFF" para apagar.

### NV-CAM01-SOLAR 4G

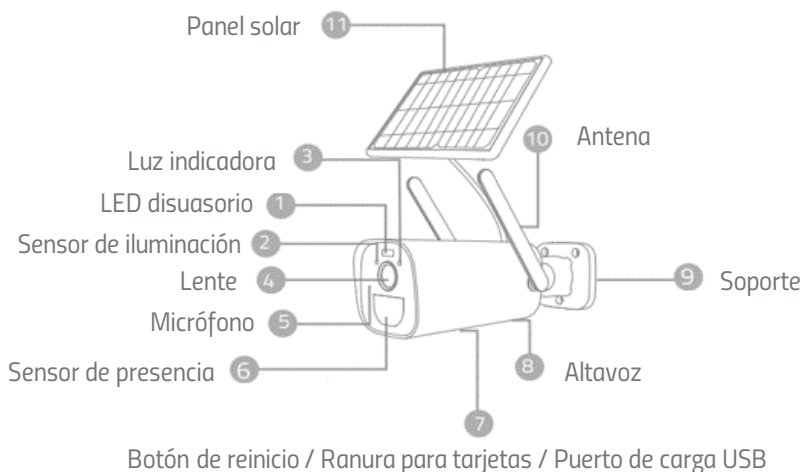

### NV-CAM02S-SOLAR 4G

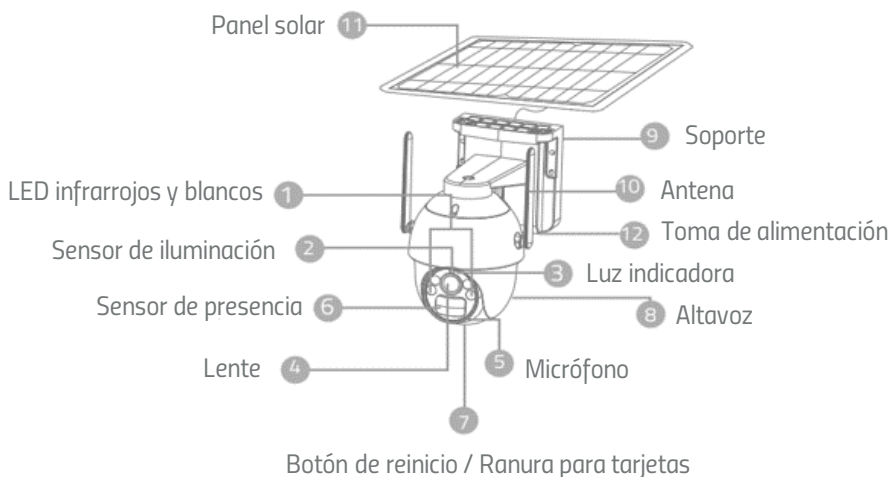

## CONSEJOS DE INSTALACION

El sensor de presencia PIR es sensible a las perturbaciones de calor y frío, tenga en cuenta lo siguiente:

Evite instalar la cámara donde se agite el flujo de aire. Por ejemplo: la salida de aire del aire acondicionado, el puerto de disipación de calor del equipo, el costado del ventilador, las inmediaciones de la cortina, etc. No instale la cámara frente al cristal o espejo. **La altura de la instalación de la cámara debe ser de 2,5 m a 3 m, la mejor distancia del disparador PIR.** No instale la cámara al revés.

### Instalación en techo/pared

- 1 Use el papel de posicionamiento de instalación para hacer agujeros, y la pared de cemento debe clavarse en el tapón de goma.
- 2 Instalación de la base de la cámara.
- 3 Instalación de soporte solar.
- 4 El panel solar se instala al aire libre y luego se conecta a la cámara.

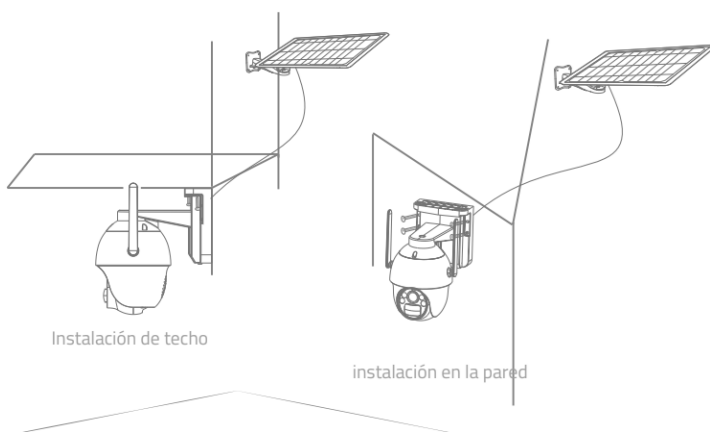

Instalación de techo

instalación en la pared

### La instalación del poste

- 1 Fije la placa de hierro detrás del compartimiento de la batería de la cámara domo con tornillos.
- 2 Instale la cámara en el poste sujetando el aro.
- 3 Instalación de soporte solar.
- 4 El panel solar se instala al aire libre y luego se conecta a la cámara.

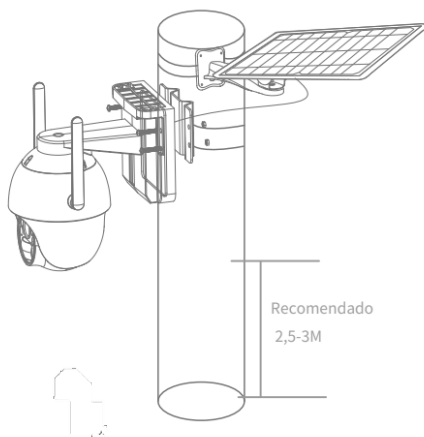

Recomendado  
2,5-3M

# AÑADE TU CÁMARA A LA APLICACIÓN MÓVIL



## ¡CONSEJO PROFESIONAL!

Antes de instalar la cámara en su lugar definitivo, primero desactivar el código PIN en la tarjeta SIM antes de insertarla en la cámara.

Para hacer esto, debes colocar la SIM en un móvil y acceder a ajustes del móvil y buscar el apartado referente a la tarjeta SIM

- 1 Descargue la app Eseecloud en su móvil o tablet.



- 2 Regístrese en la app Eseecloud para crear una nueva cuenta de usuario o inicie sesión si ya se ha registrado previamente.

- 3 Pulsa en el icono  y selecciona "Escanear código QR".

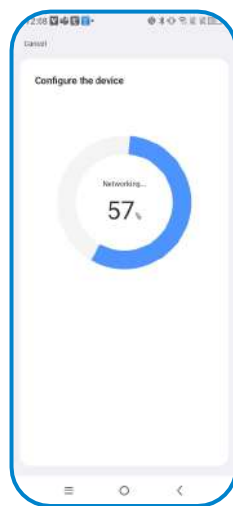
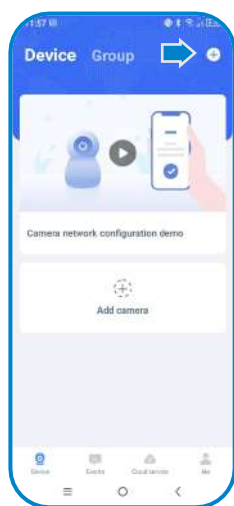

- 4 Sigue paso a paso las indicaciones de la aplicación. La cámara se ha agregado correctamente a la app Eseecloud

# AÑADE TU CÁMARA A LA APLICACIÓN MÓVIL

## CONFIGURACION MANUAL DE APN

- 1 Descargue la app Eseecloud en su móvil o Tablet.
- 2 Regístrese en la app Eseecloud para crear una nueva cuenta de usuario o inicie sesión si ya se ha registrado previamente.
- 3 Pulsa en el icono  y selecciona "Escanear código QR".

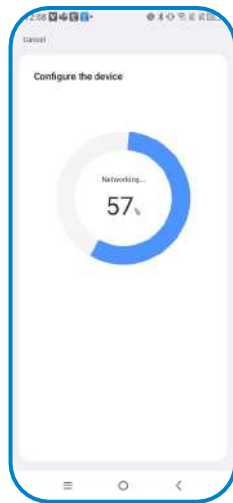
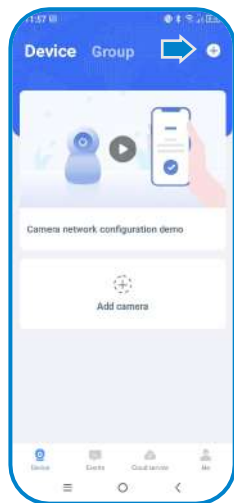

- 4 Pulsa el Botón "Ajustes APN" seguidamente ingrese los datos APN de su operador móvil (APN – tipo de Autenticación – Usuario – Contraseña). Consulte los datos APN de su operador

LISTADO DE AYUDA:



[Descarga aquí](#) la lista de operadores españoles

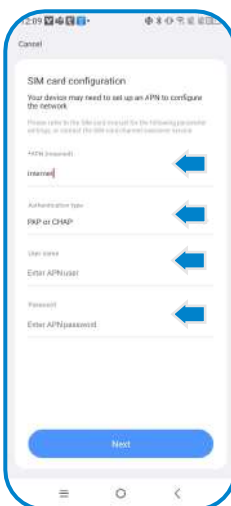
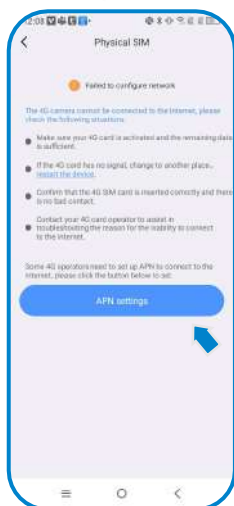

## MENU DE AJUSTES

- Menú de acciones rápidas desde la ventana de dispositivo
  - Nube - Grabación en la nube no disponible para cámaras 4G
  - Eventos - Consulta el histórico de las detecciones
  - Compartir - Permite compartir la cámara con otro usuario en la app
  - Reproducción de videos - Visualización de los videos grabados

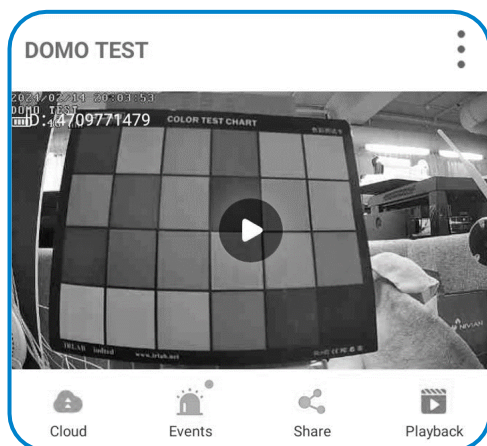

- Pulsa los "tres puntos" para acceder al menú ajustes de la cámara
  - Activar notificaciones - (ON/OFF) Activa notificaciones en la app
  - Ajustes de la cámara - Configuración general de la cámara
  - Editar nombre de dispositivo - Escribe el nombre para la cámara
  - Eliminar - Elimina la cámara de la cuenta Eseecloud y de la app

- Pulsa el botón de "Ajustes" para más configuraciones

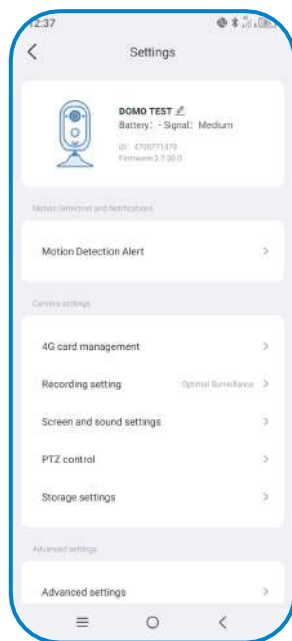
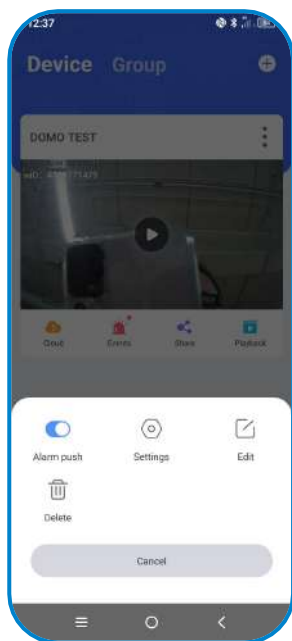
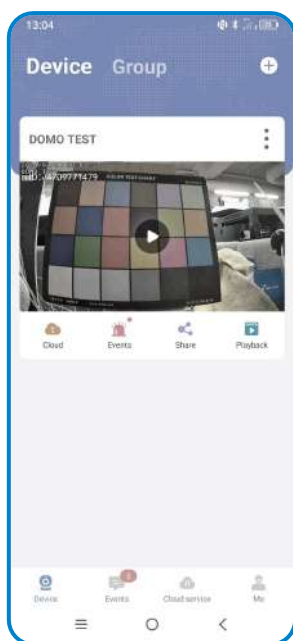

## MENU DE AJUSTES

1. Alerta de detección de movimiento
  - 1.1 Alerta de detección de movimiento (ON/OFF)
  - 1.2 Sensibilidad de detección (Bajo / Medio / Alto)
  - 1.3 Detección humanoide (ON/OFF)
  - 1.4 Configuración del área de detección de movimiento
  - 1.5 Configuración de sirena
    - 1.5.1 Interruptor de sirena (ON/OFF)
    - 1.5.2 Volumen de sirena
    - 1.5.3 Selección de tono (Por defecto / Tono de grabación)
2. Gestión de tarjetas 4G
  - 2.1 Información de la tarjeta SIM(señal / ICCID)
3. Configuración de grabación
  - 3.1 Modo de grabación
    - 3.1.1 Duración optima de la batería
    - 3.1.2 Vigilancia optima
    - 3.1.3 Grabación ininterrumpida
  - 3.2 Grabar solo cuando aparezca un humano (ON/OFF)
  - 3.3 Grabar sonido (ON/OFF)
4. Configuración de pantalla y sonido
  - 4.1 Modo de visión nocturna
    - 4.1.1 Visión nocturna a todo color
    - 4.1.2 Visión nocturna infrarroja
  - 4.2 Invierte imagen (ON/OFF)
  - 4.3 Volumen de llamadas del dispositivo
  - 4.4 Área de privacidad
5. Control de PTZ
  - 5.1 Velocidad PTZ (Bajo / Medio / Alto)
  - 5.2 Calibración PTZ
  - 5.3 Cambio de dirección de control PTZ
6. Configuración de almacenamiento
  - 6.1 Almacenamiento local
  - 6.2 Descarga archivos de video locales
  - 6.3 Formatear tarjeta de memoria
    - 6.3.1 Formatear
7. Configuraciones avanzadas
  - 7.1 indicador de estado (LED)
  - 7.2 Mensaje del dispositivo
  - 7.3 Fuerza de la señal
  - 7.4 Sincronización de tiempo
  - 7.5 Configuración de zona horaria
  - 7.6 Horario de verano (ON/OFF)
  - 7.7 Contraseña de configuración
  - 7.8 Reiniciar la cámara
  - 7.9 Eliminar y reiniciar la cámara

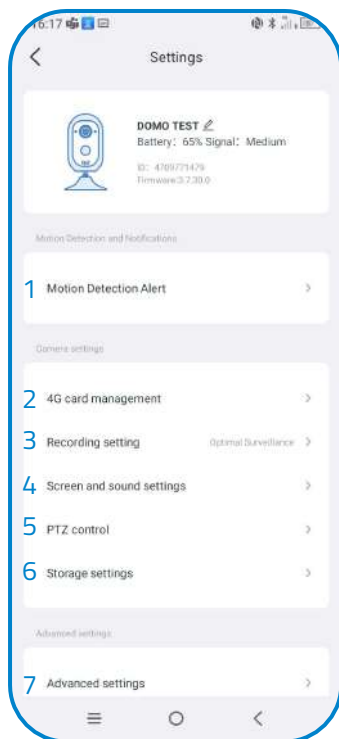

## INFORMACIÓN SOBRE LOS RIESGOS



Mantén el producto alejado de fuentes de calor y productos inflamables. No tapes el producto mientras funciona. No apliques productos agresivos o corrosivos sobre el producto.



Revisa que tu instalación eléctrica cumpla con la normativa vigente. Una instalación deficiente puede provocar fallos e incluso, incendios. No utilices alimentadores o cables en mal estado.



No manipules, apliques presión, ni desmontes el equipo. Ello anula la garantía y existe riesgo de descarga eléctrica. Si el equipo no funciona correctamente, aparece humo, olor sospechoso o ruido, desconecta la alimentación y ponte en contacto con atención al cliente.



Este producto, sus accesorios y respectivos embalajes, no son un juguete. Mantenlos alejados de los niños, personas o animales para los que pueda suponer un riesgo.

## DECLARACIÓN DE CONFORMIDAD



Producto fabricado en P.R.C.



Este producto y los accesorios suministrados, CUMPLEN CON LAS NORMAS EUROPEAS armonizadas aplicables enumeradas en las Directivas: 2014/53/UE de equipos radioeléctricos, 2014/30/UE de CE, 2011/65/UE de RoHS, 2012/19/UE de RAEE y 2006/66/CE de baterías (en el caso aplicable), así como en el resto de las directivas indicadas en la DECLARACIÓN DE CONFORMIDAD del producto.



Toda compañía, marca y nombres de producto son marcas comerciales registradas de sus respectivas compañías.

©2018 Long Xian Import Export S.L. Todos los derechos reservados.



Los productos marcados con este símbolo RAEE no pueden eliminarse como residuos municipales no clasificados en la Unión Europea. Para un RECICLAJE ADECUADO, desecha el producto y las posibles baterías en los puntos de recogida designados.

## DESCRIÇÃO DA CÂMARA

Nota:

- 1 Ligue a câmara ao painel solar e confirme que o interruptor do painel solar está ligado.
- 2 Ligar o interruptor da câmara
- 3 Coloque o interruptor do painel solar na posição "ON" para ligar e "OFF" para desligar.

### NV-CAM01-SOLAR 4G

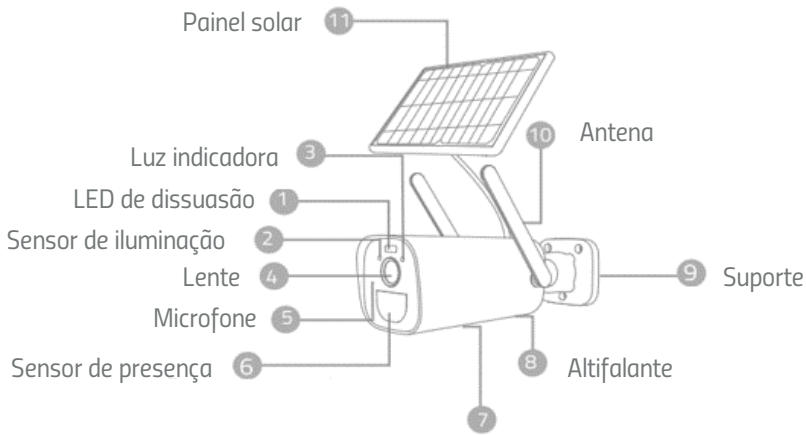

Botão de reiniciar / Ranhura para cartões / Porta de carregamento USB

### NV-CAM02S-SOLAR 4G

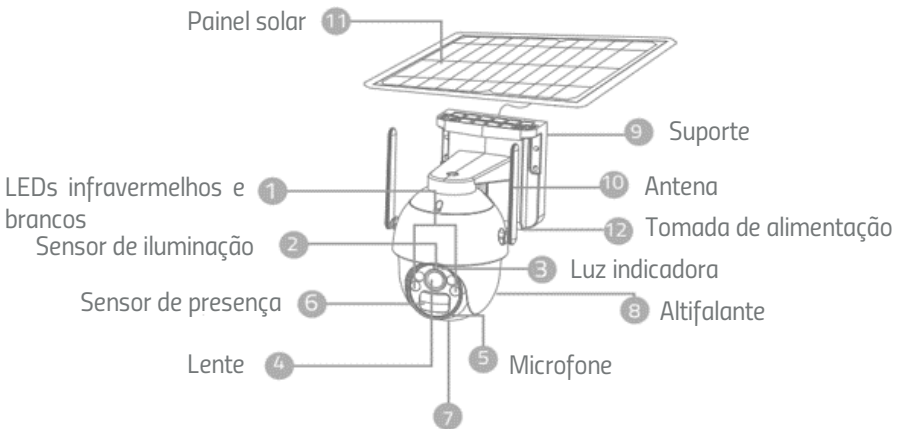

Botão de reiniciar / Ranhura do cartão



## SUGESTÕES DE INSTALAÇÃO

O sensor de presença PIR é sensível a perturbações de calor e de frio, tenha em atenção o seguinte:

Evitar instalar a câmara onde o fluxo de ar é agitado. Por exemplo: a saída de ar do ar condicionado, a porta de dissipação de calor do equipamento, o lado da ventoinha, a proximidade da cortina, etc. Não instale a câmara em frente a um vidro ou espelho. **A altura da instalação da câmara deve ser de 2,5 m a 3 m, a melhor distância do disparador PIR.** Não instale a câmara ao contrário.

### Instalação no teto/parede

- 1 Utilize o papel de posicionamento de instalação para fazer orifícios e a bucha de borracha deve ser pregada à parede de cimento.
- 2 Instalação da base da câmara.
- 3 Instalação do suporte solar.
- 4 O painel solar é instalado no exterior e depois ligado à câmara.

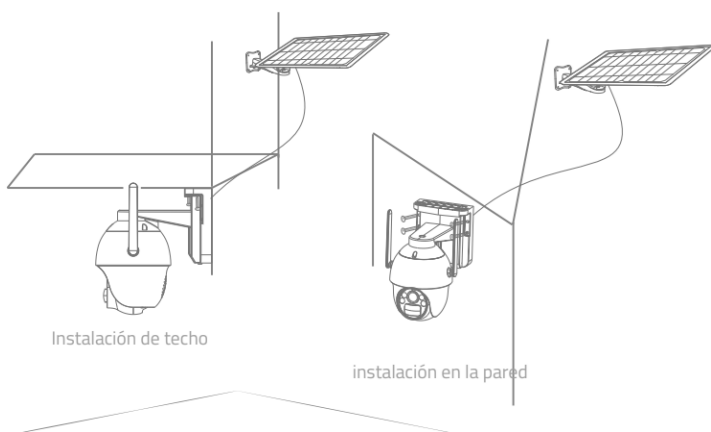

### A instalação do poste

- 1 Fixe a placa de ferro atrás do compartimento da bateria da câmara dome com parafusos.
- 2 Instale a câmara no poste fixando o anel.  
Instalação do suporte solar.
- 3 O painel solar é instalado no exterior e depois ligado à câmara.
- 4

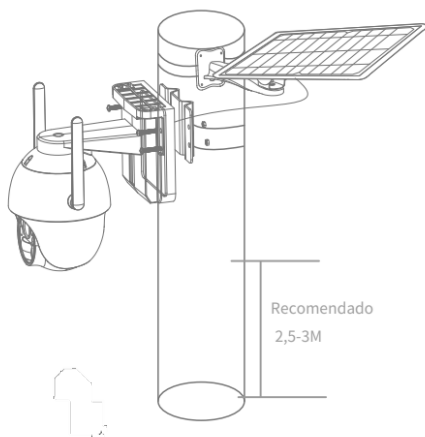

# ADICIONAR A SUA CÂMARA À APLICAÇÃO MÓVEL



## CONSELHO PROFISSIONAL!

Antes de instalar a câmara no seu local definitivo, desative o código PIN do cartão SIM antes de o inserir na câmara. Para tal, deve colocar o cartão SIM num telemóvel e ir às definições do telemóvel e procurar a secção relativa ao cartão SIM.

- 1 Descarregue a aplicação Eseecloud no seu telemóvel ou tablet.



- 2 Registe-se na aplicação Eseecloud para criar uma conta de utilizador ou inicie sessão se já estiver registado.

- 3 Clique no ícone  selecione "Digitalizar código QR".

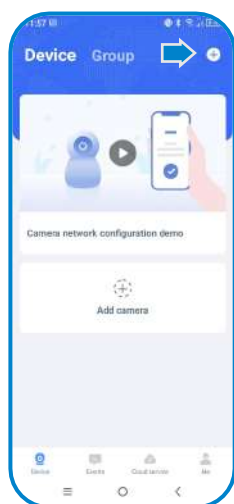

- 4 Siga as instruções passo a passo na aplicação.  
A câmara foi adicionada com sucesso à aplicação Eseecloud.

# ADICIONAR A SUA CÂMARA À APLICAÇÃO MÓVEL

## CONFIGURAÇÃO MANUAL DA APN

- 1 Descarregue a app Eseecloud no seu telemóvel ou tablet.
- 2 Registe-se na aplicação Eseecloud para criar uma conta de utilizador ou inicie sessão se já estiver registado.
- 3 Clique no ícone  e selecione "Digitalizar código QR".

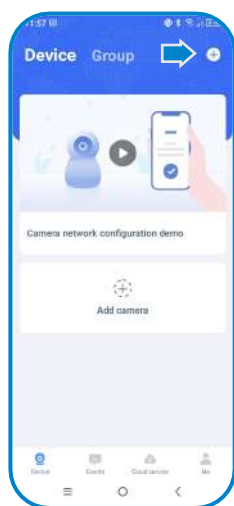

- 4 Premir o botão "Definições APN" e, em seguida, introduzir os dados APN do seu operador móvel (APN - Tipo de autenticação - Utilizador - Palavra-passe). Ver os dados APN do seu operador

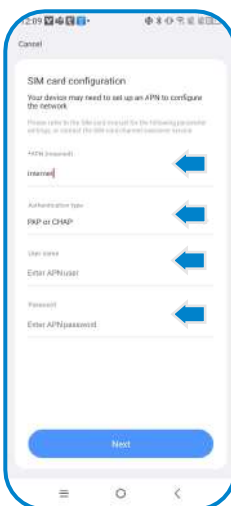
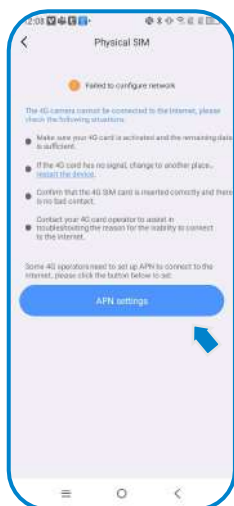

## MENU DE AJUSTES

- Menu de ação rápida a partir da janela do dispositivo
  - Nuvem - A gravação na cloud não está disponível para câmaras 4G
  - Eventos - Ver o histórico de deteção
  - Partilhar - Permite partilhar a câmara com outro utilizador na aplicação
  - Reprodução de vídeo - Ver vídeos gravados

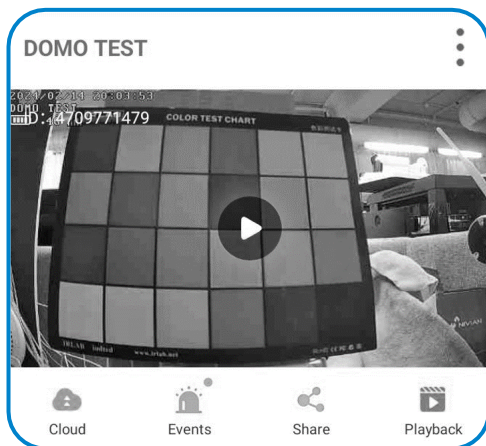

- Prima os "três pontos" para aceder ao menu de definições da câmara.
  - Ativar notificações - (ON/OFF) Ativar as notificações na aplicação
  - Definições da câmara - Definições gerais da câmara
  - Editar nome do dispositivo - Introduzir o nome da câmara
  - Eliminar - Eliminar a câmara da conta Eseecloud e da aplicação

- Prima o botão "Ajustes" para mais ajustes

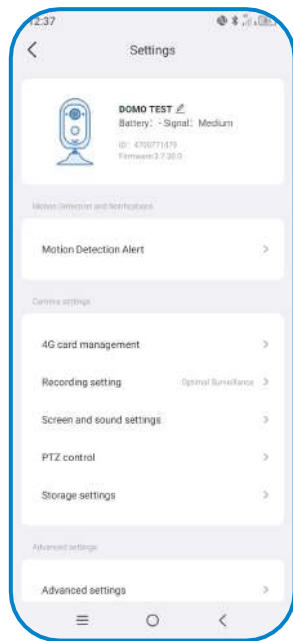
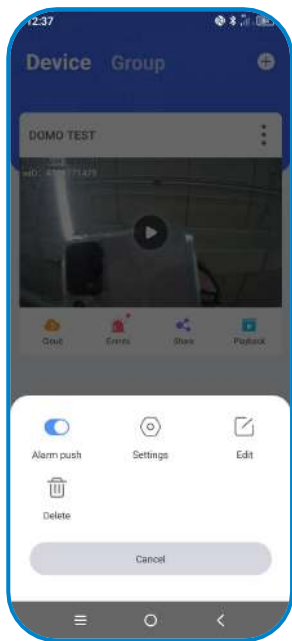
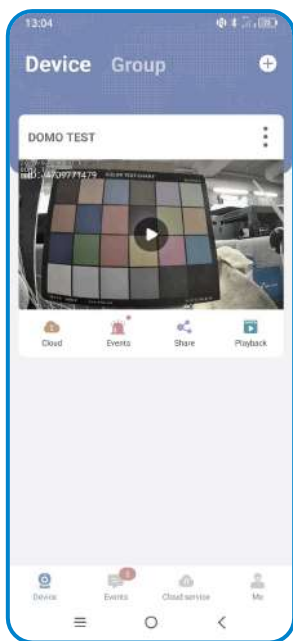

## MENU DE AJUSTES

1. Alerta de deteção de movimento
  - 1.1 Alerta de deteção de movimento (ON/OFF)
  - 1.2 Sensibilidade da deteção (Baixa / Média / Alta)
  - 1.3 Deteção humanoide (ON/OFF)
  - 1.4 Configuração da área de deteção de movimento
  - 1.5 Configuração da sirene
    - 1.5.1 Interruptor da sirene (ON/OFF)
    - 1.5.2 Volume da sirene
    - 1.5.3 Seleção do tom (predefinição / tom de gravação)
2. Gestão do cartão 4G
  - 2.1 Informações do cartão SIM (sinal / ICCID)
3. Configuração da gravação
  - 3.1 Modo de gravação
    - 3.1.1 Duração ótima da bateria
    - 3.1.2 Vigilância ótima
    - 3.1.3 Gravação ininterrupta
  - 3.2 Gravar apenas quando aparece uma pessoa (ON/OFF)
  - 3.3 Gravar som (ON/OFF)
4. Definições do ecrã e do som
  - 4.1 Modo de visão noturna
    - 4.1.1 Visão noturna a cores
    - 4.1.2 Visão noturna com infravermelhos
  - 4.2 Imagem invertida (ON/OFF)
  - 4.3 Volume de chamada do dispositivo
  - 4.4 Área de privacidade
5. Controlo PTZ
  - 5.1 Velocidade PTZ (Baixa / Média / Alta)
  - 5.2 Calibração PTZ
  - 5.3 Mudança de direção do controlo PTZ
6. Configuração do armazenamento
  - 6.1 Armazenamento local
  - 6.2 Transferir ficheiros de vídeo locais
  - 6.3 Formatar cartão de memória
    - 6.3.1 Formatar
7. Definições avançadas
  - 7.1 Indicador de estado (LED)
  - 7.2 Mensagem do dispositivo
  - 7.3 Intensidade do sinal
  - 7.4 Sincronização da hora
  - 7.5 Definição do fuso horário
  - 7.6 Hora de verão (ON/OFF)
  - 7.7 Palavra-passe de configuração
  - 7.8 Reiniciar a câmara
  - 7.9 Apagar e reiniciar a câmara

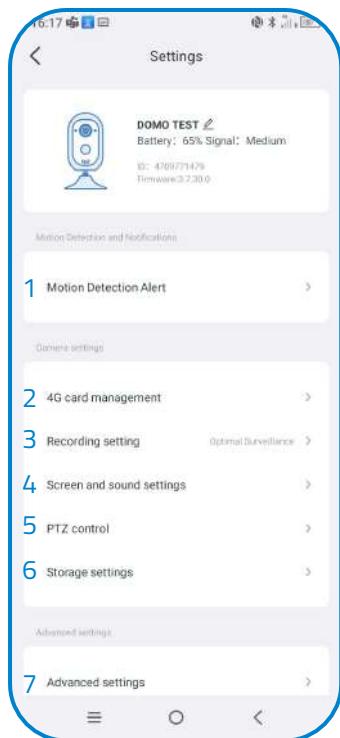

## INFORMAÇÕES SOBRE RISCOS



Manter o produto afastado de fontes de calor e de produtos inflamáveis. Não tape o produto durante o funcionamento. Não aplicar produtos agressivos ou corrosivos sobre o produto.



Verifique se a sua instalação elétrica está conforme os regulamentos em vigor. Uma instalação deficiente pode provocar avarias e até incêndios. Não utilize fontes de alimentação ou cabos que estejam em mau estado.



Não adulterar, pressionar ou desmontar o equipamento. Isto invalida a garantia e existe o risco de choque elétrico. Se o equipamento não funcionar corretamente, se aparecer fumo, odor suspeito ou ruído, desligue a fonte de alimentação e contacte o serviço de apoio ao cliente.



Este produto, os seus acessórios e a embalagem não são um brinquedo. Mantenha-os afastados de crianças, pessoas ou animais para os quais possam representar um risco.

## DECLARAÇÃO DE CONFORMIDADE



Produto fabricado em R.P.C.



Este produto e os acessórios fornecidos ESTÃO CONFORME COM AS NORMAS EUROPEIAS harmonizadas aplicáveis, conforme listado nas seguintes Diretivas: 2014/53/UE para equipamento de rádio, 2014/30/UE para CE, 2011/65/UE para RoHS, 2012/19/UE para REEE e 2006/66/CE para baterias (quando aplicável), bem como as outras diretivas listadas na DECLARAÇÃO DE CONFORMIDADE do produto.



Todos os nomes de empresas, marcas e produtos são marcas registadas das respetivas empresas.

©2018 Long Xian Import Export S.L. Todos os direitos reservados.



Os produtos marcados com este símbolo REEE não podem ser eliminados como resíduos urbanos indiferenciados na União Europeia. Para uma REICLAGEM adequada, elimine o produto e as baterias nos pontos de recolha designados.